

Angelo Italia™

 COLLECTION





SOSL

STANLEY OEM SOFAS LIMITED

26 YEARS OF PASSION. Our dream was born in the strangest of places – a car shed. Our first car adorned in our upholstery sat there smiling at us. 26 years ago our first customers came knocking – the General Motors Vendor Development office. We interacted with state-of-the-art eco-friendly tanneries in Australia, Germany, Austria, Sweden, Italy, Mexico, Brazil, and Argentina to understand how exclusive upholstery leathers for high-spec aircraft, automobiles, and furniture were developed. We ventured into Leather Sofas in 1999 and then slowly diversified into Full Home Furnishing. What keeps us going today are our hundred thousand satisfied customers, our vision to be the world’s best, and our ever-burning zeal to excel in every aspect of leather quality, ergonomics, and design.

WHY WE EXIST

To emerge as an Indian luxury lifestyle brand capable of designing, developing and manufacturing to international specifications & standards. To make “Made in India” a globally recognized entity, by passionately creating and consistently delivering objects of joy.



INDEX

Angelo Italia Collection

Angelo Italia™

COLLECTION

AIC 01 08.



1 STR



2 STR



3 STR



3 STR + LH / RH DAYBED

AIC 06 18.



1 STR



2 STR



3 STR



2 STR + LH / RH DAYBED

AIC 02 10.



1 STR



2 STR



3 STR



3 STR + LH / RH DAYBED

AIC 07 20.



2 STR



2 STR + U CNR + 2 STR

AIC 03 12.



1 STR



2 STR



3 STR



3 STR + LH / RH DAYBED

AIC 08 22.



ODD CHAIR

AIC 09 24.



ODD CHAIR

AIC 04 14.



1 STR



2 STR



3 STR

AIC 10 26.



RECLINER

AIC 11 28.



RECLINER

AIC 12 30.



RECLINER

AIC 05 16.



1 STR



2 STR



3 STR



2 STR + LH / RH DAYBED



2STR + U CNR + 2STR

UPHOLSTERY OPTION :
SCANDINAVIA MAX / NEW ORLANDO

LEATHER :

All our leathers are from 100% bovine hide with Italian tannage. Our leathers are authentic with their inherent strength, grace and beauty. Our authentic top grain leather becomes more beautiful and more comfortable as it ages. Leather thickness ranges from 1.0mm to 1.6mm. Our leathers are warranted against splitting and colour bleed under normal usage.

TIMBER :

We use high quality FSI certified kiln dried Canadian pine wood with exceptional durability and sturdiness. All our timbers are moisture protected to reduce the possibility of seasonal expansion or contraction.

PLYWOOD :

We use plywood of high strength and durability for our frames. Plywood's are moisture and termite resistant which enhances the life of our furniture.

FOAM / WEBBING :

We use high density polyurethane foams which have excellent mechanical and tensile properties. All our foams have passed required laboratory tests and have high durability. It retains its original shape and strength for several years, offering long lasting and efficient service. We use a combination of foam from 20 D to 50 D to achieve required comfort. Webbing is imported from Italy with very high spec of elasticity and loadability.

MECHANISM :

We use patented mechanisms and motors from Motion Italia(Italy), Leggett & Platt(U.S) & Ciar (Italy) for motion sofas. Our mechanisms are tested for 25000 human cycles at 250Lbs.

THREAD :

We use 3 ply Nylon 6.6 bonded threads which are of exceptionally high abrasion resistance. Neat and clean seams achieved due to low stretch and excellent recovery properties of our threads.

STAINLESS STEEL :

We use stainless steel of 304 grade which is a strong and durable metal. It has a relatively low carbon content, further reducing its vulnerability to corrosion and oxidation.

AIC 01

Angelo Italia Collection



DATA SHEET

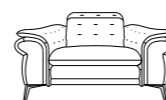

1 STR

TW - 51" / ISW - 25"
TW - 129.5cm / ISW - 61cm

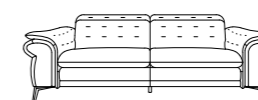

2 STR

TW - 76.5" / ISW - 50"
TW - 194cm / ISW - 127cm

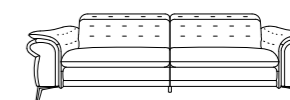

3 STR

TW - 89" / ISW - 63"
TW - 226cm / ISW - 160cm

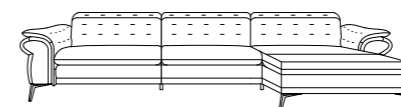

3 STR + RH DAYBED

TW - 121" / ISW - 94.5"
TW - 307cm / ISW - 240cm
DBTW - 46"(117CM) / DBISW - 33"(84CM)
DBTD - 71.5"(181.5CM) / DBSD - 50"(127CM)



3 STR + LH DAYBED

TW - 121" / ISW - 94.5"
TW - 307cm / ISW - 240cm
DBTW - 46"(117CM) / DBISW - 33"(84CM)
DBTD - 71.5"(181.5CM) / DBSD - 50"(127CM)

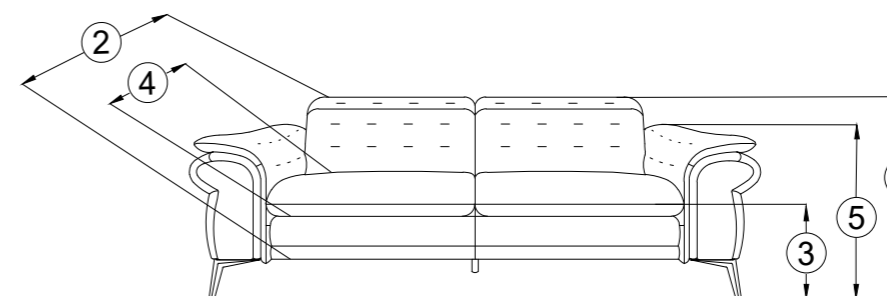

- 1. TOTAL HEIGHT - 32"(81cm)
- 2. TOTAL DEPTH - 44"(112cm)
- 3. SEAT HEIGHT - 20.5"(52cm)
- 4. SEAT DEPTH - 22.5"(57cm)
- 5. ARM REST HEIGHT - 26"(66cm)

AIC 02

Angelo Italia Collection

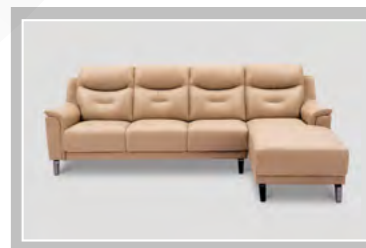

DATA SHEET



1 STR

TW - 39" / ISW - 22"
TW - 99cm / ISW - 56cm

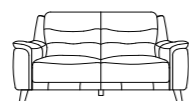

2 STR

TW - 62" / ISW - 44.5"
TW - 157.5cm / ISW - 113cm

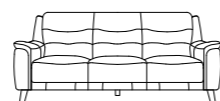

3 STR

TW - 85" / ISW - 67"
TW - 216cm / ISW - 170cm

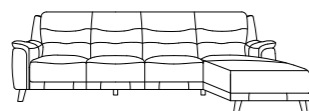

3 STR + RH DAYBED

TW - 110" / ISW - 92"
TW - 279.5cm / ISW - 231cm
DBTW - 31.5"(80CM) / DBISW - 23"(58.5CM)
DBTD - 70.5"(179CM) / DBSD - 54"(137CM)

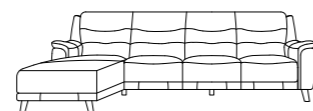

3 STR + LH DAYBED

TW - 110" / ISW - 92"
TW - 279.5cm / ISW - 231cm
DBTW - 31.5"(80CM) / DBISW - 23"(58.5CM)
DBTD - 70.5"(179CM) / DBSD - 54"(137CM)

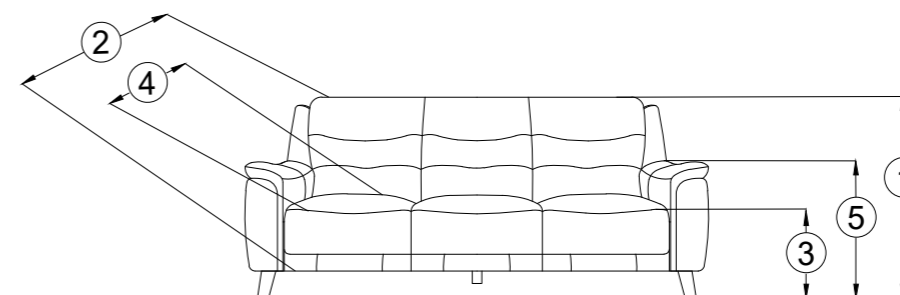

- 1. TOTAL HEIGHT - 39"(99cm)
- 2. TOTAL DEPTH - 42"(107cm)
- 3. SEAT HEIGHT - 19"(48cm)
- 4. SEAT DEPTH - 21.5"(54.5cm)
- 5. ARM REST HEIGHT - 25"(63.5cm)

AIC 03

Angelo Italia Collection



DATA SHEET

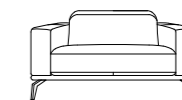

1 STR

TW - 43" / ISW - 26"
 TW - 109cm / ISW - 66cm

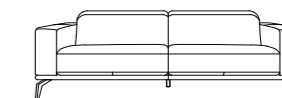

2 STR

TW - 69.5" / ISW - 52.5"
 TW - 176.5cm / ISW - 133.5cm

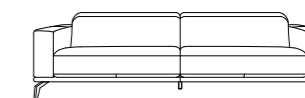

3 STR

TW - 87" / ISW - 70"
 TW - 221cm / ISW - 178cm

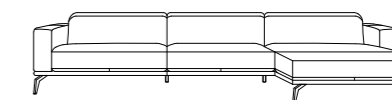

3 STR + RH DAYBED

TW - 123" / ISW - 106"
 TW - 312cm / ISW - 269cm
 DBTW - 44"(112CM) / DBISW - 35.5"(90CM)
 DBTD - 71"(180.5CM) / DBSD - 50.5"(128CM)

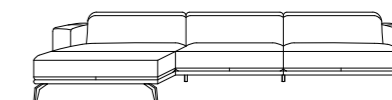

3 STR + LH DAYBED

TW - 123" / ISW - 106"
 TW - 312cm / ISW - 269cm
 DBTW - 44"(112CM) / DBISW - 35.5"(90CM)
 DBTD - 71"(180.5CM) / DBSD - 50.5"(128CM)

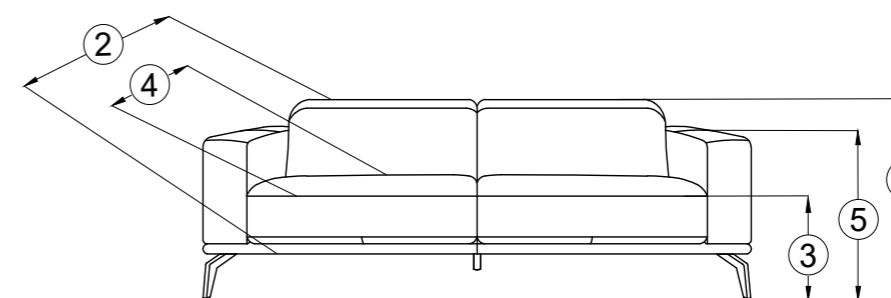

- 1. TOTAL HEIGHT - 30"(76cm)
- 2. TOTAL DEPTH - 43"(109cm)
- 3. SEAT HEIGHT - 18.5"(47cm)
- 4. SEAT DEPTH - 24"(61cm)
- 5. ARM REST HEIGHT - 24"(61cm)

AIC 04

Angelo Italia Collection



DATA SHEET



1 STR

TW - 52.5" / ISW - 25"
 TW - 133.5cm / ISW - 63.5cm

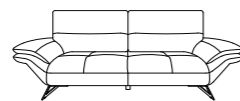

2 STR

TW - 79.5" / ISW - 52"
 TW - 202cm / ISW - 132cm

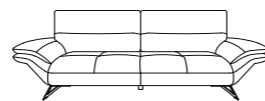

3 STR

TW - 87.5" / ISW - 60"
 TW - 222.5cm / ISW - 152.5cm

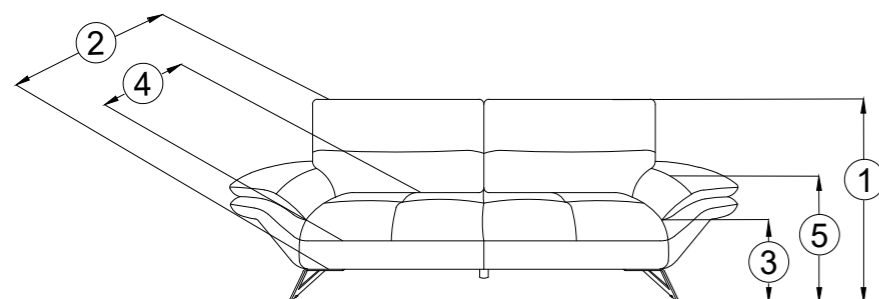

- 1. TOTAL HEIGHT - 37"(94cm)
- 2. TOTAL DEPTH - 57"(145cm)
- 3. SEAT HEIGHT - 18.5"(47cm)
- 4. SEAT DEPTH - 24"(61cm)
- 5. ARM REST HEIGHT - 24"(61cm)

AIC 05

Angelo Italia Collection



DATA SHEET

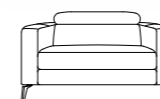

1 STR

TW - 44.5" / ISW - 30"
TW - 113cm / ISW - 76cm

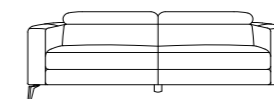

2 STR

TW - 74.5" / ISW - 60"
TW - 189.5cm / ISW - 152cm

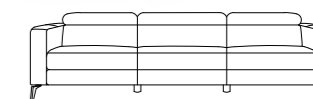

3 STR

TW - 104.5" / ISW - 90"
TW - 265.5cm / ISW - 229cm

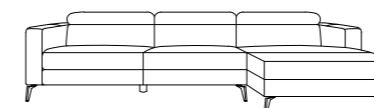

2 STR + RH DAYBED

TW - 104.5" / ISW - 90"
TW - 265.5cm / ISW - 229cm
DBTW - 37.25"(94.5CM) / DBISW - 30"(76CM)
DBTD - 67"(170CM) / DBSD - 47"(119.5CM)

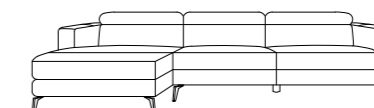

2 STR + LH DAYBED

TW - 104.5" / ISW - 90"
TW - 265.5cm / ISW - 229cm
DBTW - 37.25"(94.5CM) / DBISW - 30"(76CM)
DBTD - 67"(170CM) / DBSD - 47"(119.5CM)

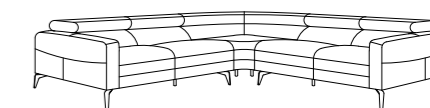

2 STR + U CNR + 2 STR

TW - 120"(305cm) X 120"(305cm)
ISW - 91"(231cm) X 91"(231cm)

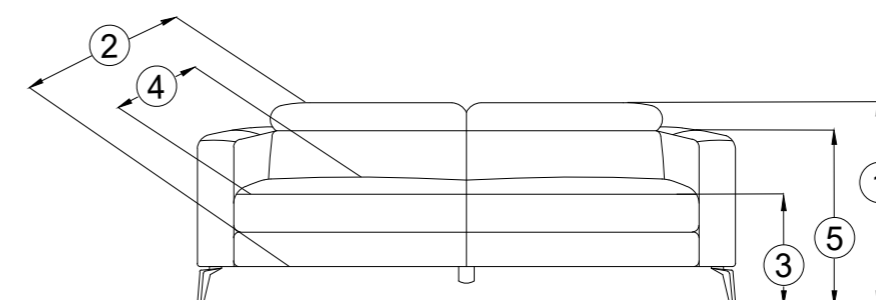

- 1. TOTAL HEIGHT - 29.5"(75cm)
- 2. TOTAL DEPTH - 43.5"(110.5cm)
- 3. SEAT HEIGHT - 20.5"(52cm)
- 4. SEAT DEPTH - 23"(58.5cm)
- 5. ARM REST HEIGHT - 24.5"(62.5cm)

AIC 06

Angelo Italia Collection



DATA SHEET

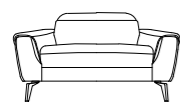

1 STR

TW - 50.5" / ISW - 30"
TW - 128.5cm / ISW - 76cm

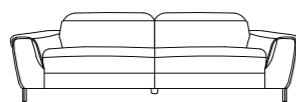

2 STR

TW - 80.5" / ISW - 60"
TW - 204.5cm / ISW - 152.5cm

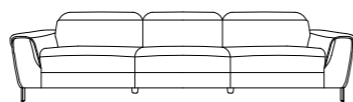

3 STR

TW - 111" / ISW - 91"
TW - 282cm / ISW - 231cm

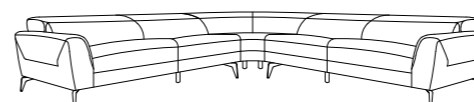

2 STR + U CNR + 2 STR

TW - 127"(322.5cm) X 127"(322.5cm)
ISW - 91"(231cm) X 91"(231cm)

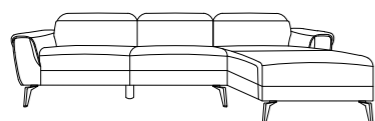

2 STR + RH DAYBED

TW - 112" / ISW - 91"
TW - 265.5cm / ISW - 231cm
DBTW - 41.5"(105.5CM) / DBISW - 31"(79CM)
DBTD - 68"(173CM) / DBSD - 46"(117CM)

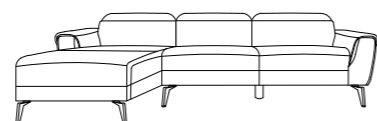

2 STR + LH DAYBED

TW - 112" / ISW - 91"
TW - 265.5cm / ISW - 231cm
DBTW - 41.5"(105.5CM) / DBISW - 31"(79CM)
DBTD - 68"(173CM) / DBSD - 46"(117CM)

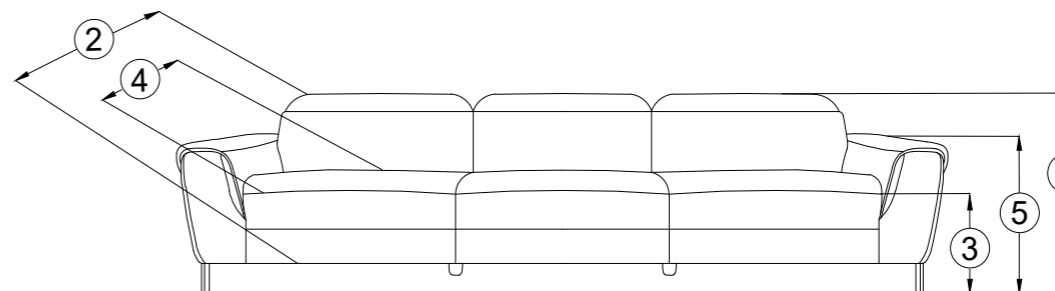

- 1. TOTAL HEIGHT - 30.5"(77.5cm)
- 2. TOTAL DEPTH - 43"(109.5cm)
- 3. SEAT HEIGHT - 21"(53.5cm)
- 4. SEAT DEPTH - 21.5"(54.5cm)
- 5. ARM REST HEIGHT - 25"(63.5cm)

AIC 07

Angelo Italia Collection



DATA SHEET



2 STR

TW - 83.5" / ISW - 55"
TW - 212cm / ISW - 140cm



2 STR + U CNR + 2 STR

TW - 133" X 133"
TW - 338cm X 338cm

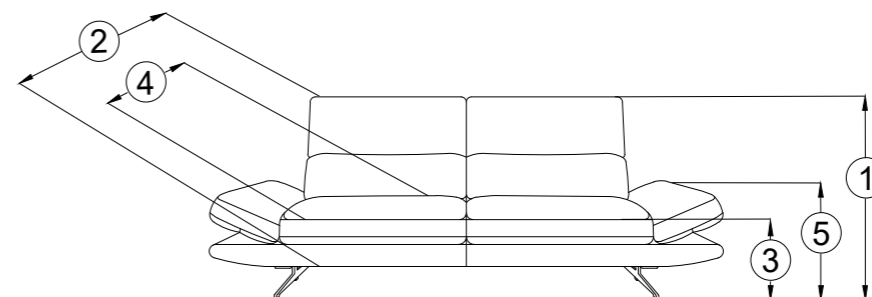

- 1. TOTAL HEIGHT - 38"(96.5cm)
- 2. TOTAL DEPTH - 55.5"(141cm)
- 3. SEAT HEIGHT - 18"(46cm)
- 4. SEAT DEPTH - 22"(56cm)
- 5. ARM REST HEIGHT - 25.5"(65cm)

AIC 08 ODD CHAIR

Angelo Italia Collection



DATA SHEET

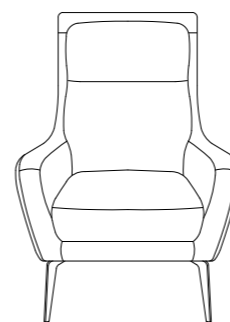

- 1. TOTAL HEIGHT - 43.5"(110.5cm)
- 2. TOTAL WIDTH - 33"(84cm)
- 3. TOTAL DEPTH - 38"(96.5cm)
- 4. SEAT HEIGHT - 20"(51cm)
- 5. SEAT WIDTH - 22"(56cm)
- 6. SEAT DEPTH - 21"(53.5cm)
- 7. ARM REST HEIGHT - 24.75"(63cm)
- 8. LEG HEIGHT - 10.5"(27cm)

AIC 09 ODD CHAIR

Angelo Italia Collection



DATA SHEET

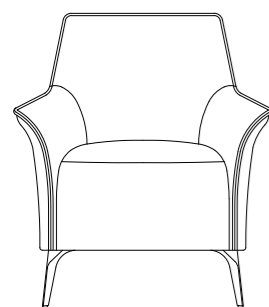

- 1. TOTAL HEIGHT - 36"(91.5cm)
- 2. TOTAL WIDTH - 29.5"(75cm)
- 3. TOTAL DEPTH - 31"(79cm)
- 4. SEAT HEIGHT - 20"(51cm)
- 5. SEAT WIDTH - 18.5"(47cm)
- 6. SEAT DEPTH - 19.5"(49.5cm)
- 7. ARM REST HEIGHT - 25.5"(65cm)
- 8. LEG HEIGHT - 7"(18cm)

AIC 10 RECLINER

Angelo Italia Collection



DATA SHEET

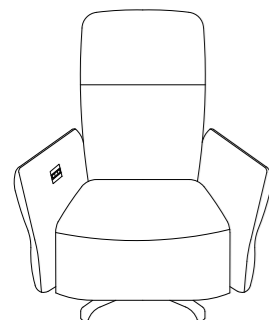

- 1. TOTAL HEIGHT - 44"(112cm)
- 2. TOTAL WIDTH - 30.5"(77.5cm)
- 3. TOTAL DEPTH - 36"(91.5cm)
- 4. SEAT HEIGHT - 21"(53.5cm)
- 5. SEAT WIDTH - 22.5"(57cm)
- 6. SEAT DEPTH - 22"(56cm)
- 7. ARM REST HEIGHT - 25"(63.5cm)

AIC 11 RECLINER

Angelo Italia Collection



DATA SHEET

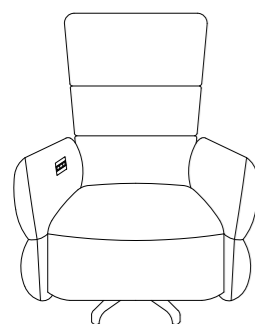

- 1. TOTAL HEIGHT - 44"(112cm)
- 2. TOTAL WIDTH - 30"(76cm)
- 3. TOTAL DEPTH - 35.5"(90cm)
- 4. SEAT HEIGHT - 20.5"(52cm)
- 5. SEAT WIDTH - 20"(51cm)
- 6. SEAT DEPTH - 22"(56cm)
- 7. ARM REST HEIGHT - 26.5"(67.5cm)

AIC 12 RECLINER

Angelo Italia Collection



DATA SHEET

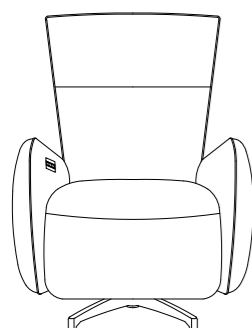

- 1. TOTAL HEIGHT - 43.5"(110.5cm)
- 2. TOTAL WIDTH - 30"(76cm)
- 3. TOTAL DEPTH - 39"(99cm)
- 4. SEAT HEIGHT - 21"(53.5cm)
- 5. SEAT WIDTH - 21"(53.5cm)
- 6. SEAT DEPTH - 23"(58.5cm)
- 7. ARM REST HEIGHT - 26"(66cm)

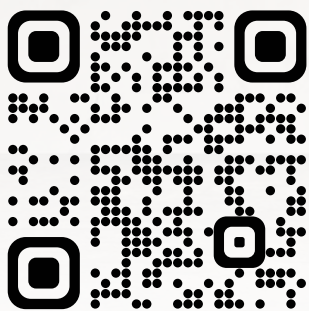

www.sosl.co.in

Manufactured at:
Stanley OEM Sofas Limited, 52,66 & 67,
Bommasandra Jigani Link Rd.,
Jigani Industrial Area

CUSTOMER CARE: **enquiry@sosl.co.in**
CALL: **+91 99011 87996**